

VB1 (19/40)

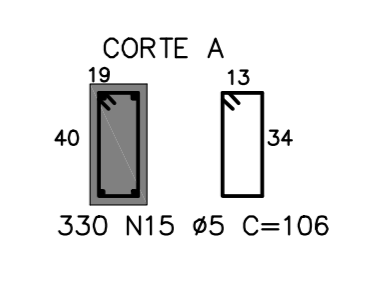

N	Q	UNI	TOTAL
1	12.5	2	25
2	15	3	45
3	12.5	2	25
4	12.5	2	25
5	12.5	2	25
6	12.5	2	25
7	16	2	32
8	5	1	5
9	12.5	2	25
10	2	1	2
11	10	2	20
12	2	1	2
13	10	2	20
14	2	1	2
15	5	1	5

VB2 (19/40)

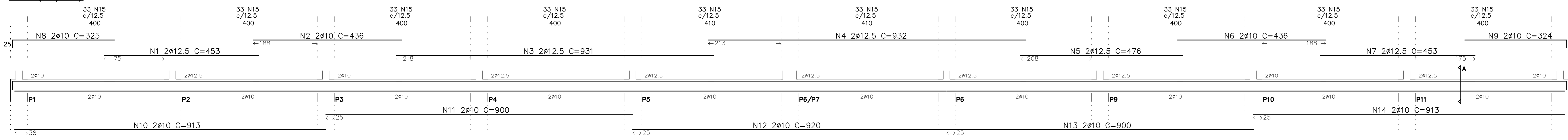
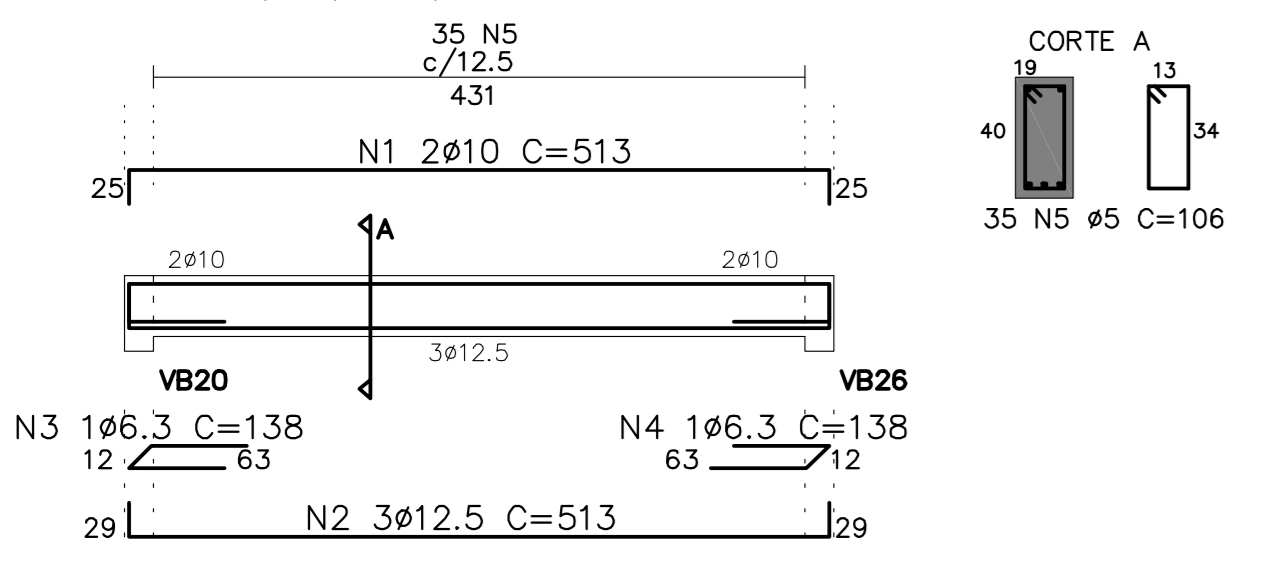

VB4 (19/40)

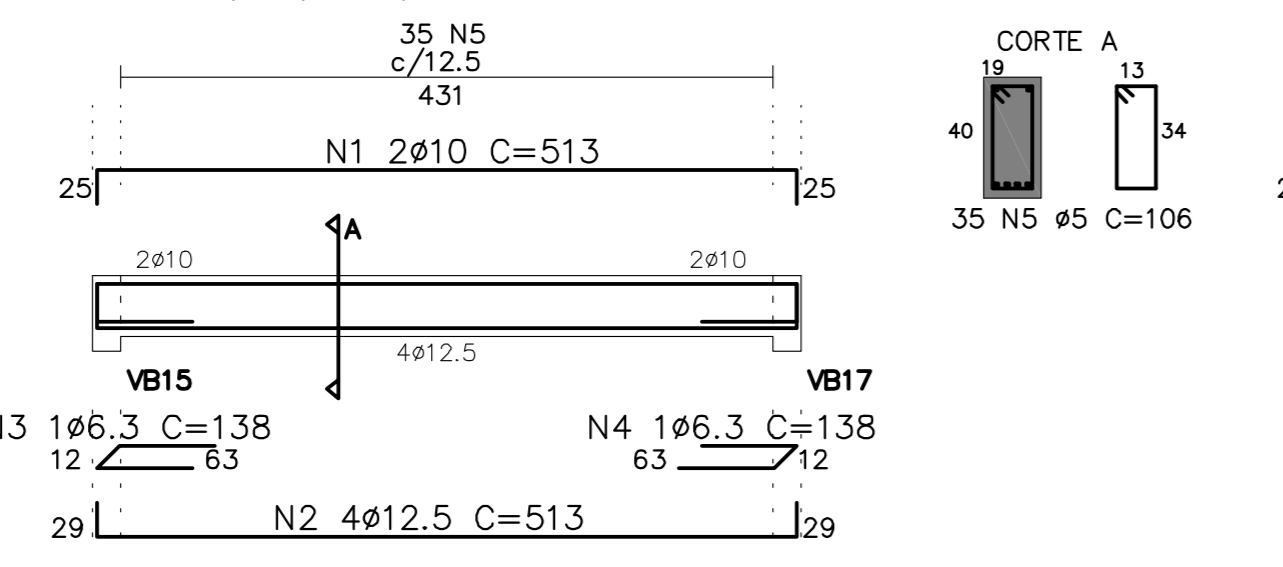

VB7 (19/40)

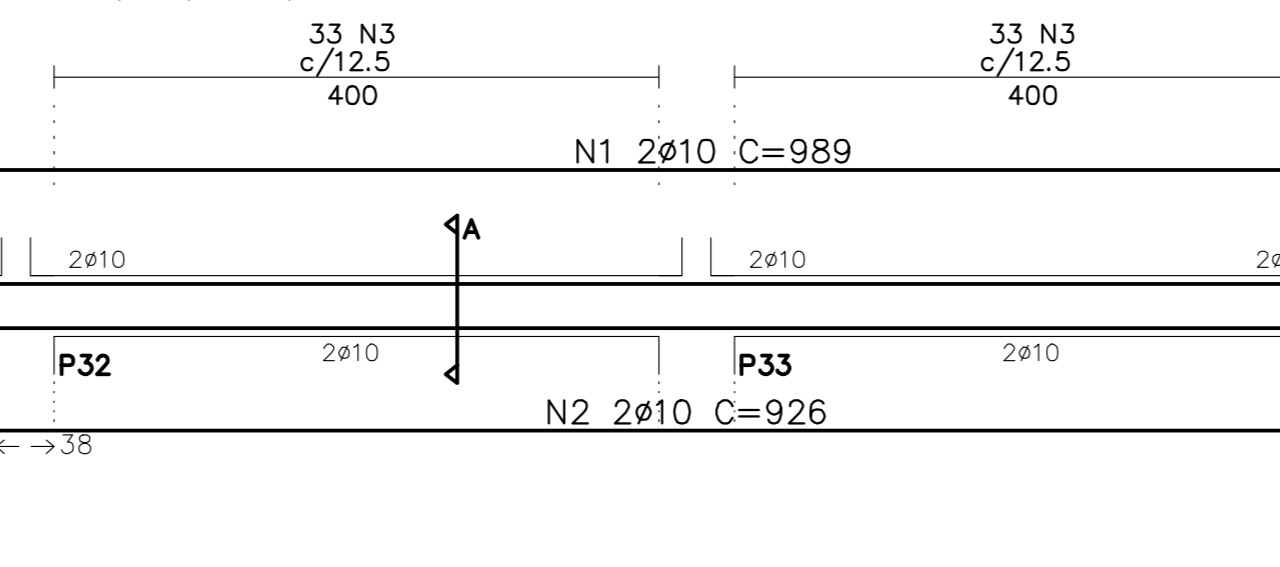

VB8 (19/40)

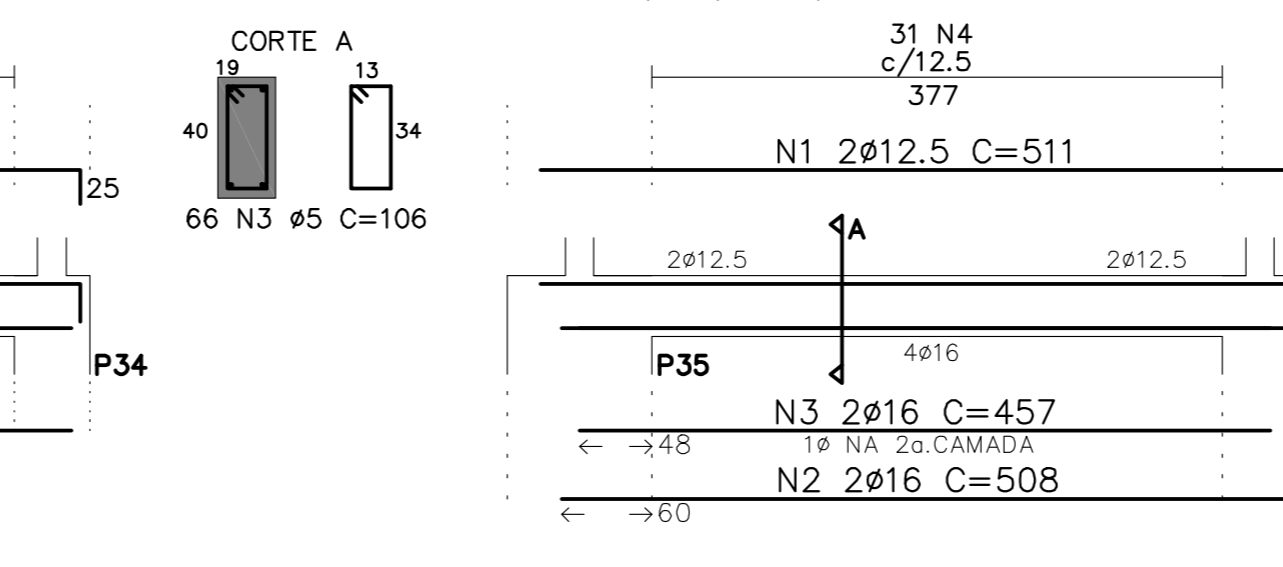

VB9 (19/30)

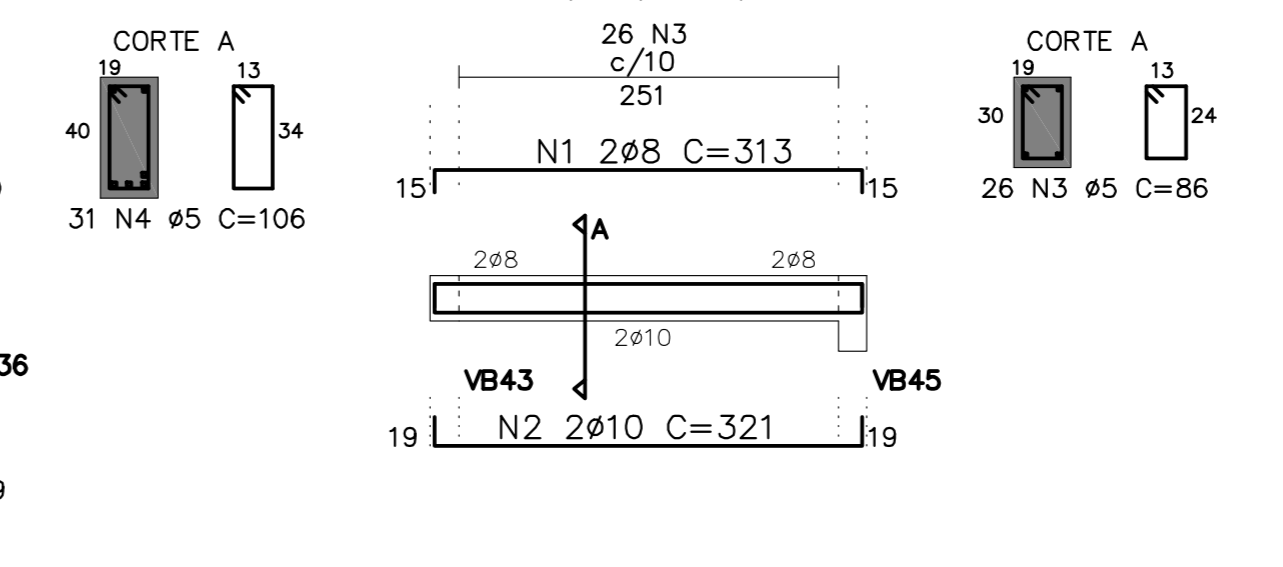

VB16 (19/30)

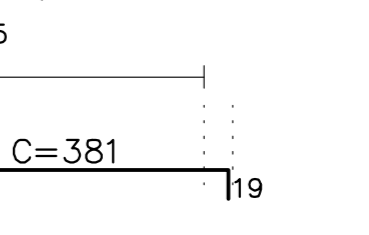
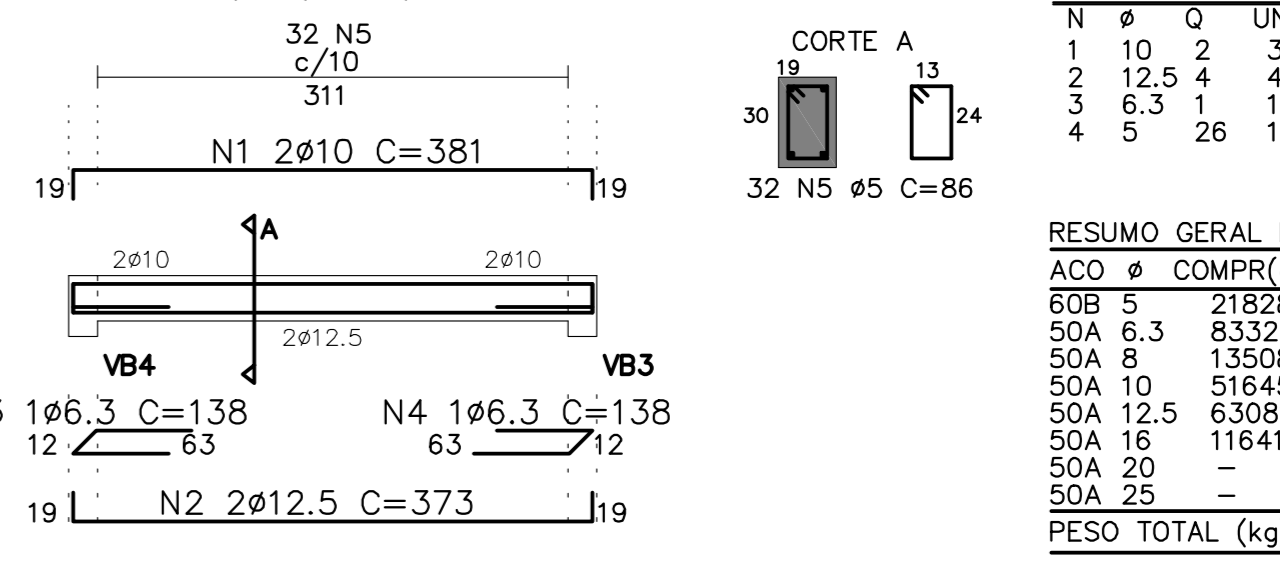

N	Q	UNI	TOTAL
1	12.5	2	25
2	10	2	20
3	5	1	5
4	12.5	2	25
5	12.5	2	25
6	12.5	2	25
7	12.5	2	25
8	10	2	20
9	10	2	20
10	12	2	24
11	12	2	24
12	12	2	24
13	12	2	24
14	12	2	24
15	12	2	24
16	12	2	24
17	12	2	24
18	12	2	24
19	12	2	24
20	12	2	24
21	12	2	24
22	12	2	24
23	12	2	24
24	12	2	24
25	12	2	24
26	12	2	24
27	12	2	24
28	12	2	24
29	12	2	24
30	12	2	24
31	12	2	24
32	12	2	24
33	12	2	24
34	12	2	24
35	12	2	24

VB3 (19/40)

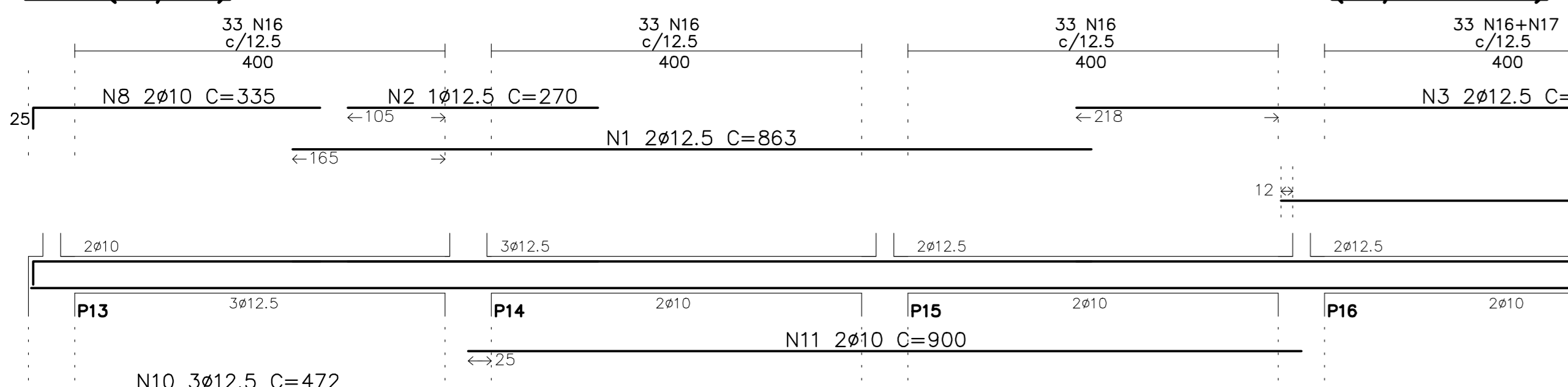

(19/40+ABA)

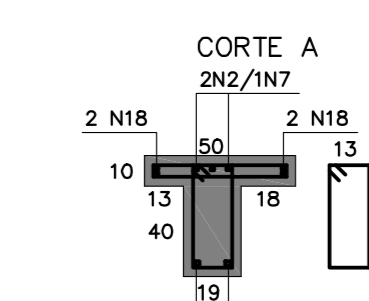
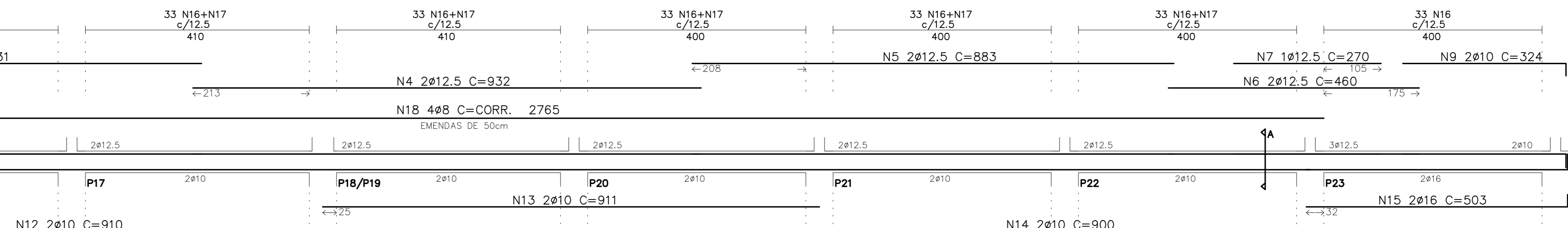

N	Q	UNI	TOTAL
1	12.5	2	25
2	12.5	2	25
3	12.5	2	25
4	12.5	2	25
5	12.5	2	25
6	12.5	2	25
7	12.5	2	25
8	12.5	2	25
9	12.5	2	25
10	12.5	2	25
11	12.5	2	25
12	12.5	2	25
13	12.5	2	25
14	12.5	2	25
15	12.5	2	25
16	12.5	2	25
17	12.5	2	25
18	12.5	2	25
19	12.5	2	25
20	12.5	2	25
21	12.5	2	25
22	12.5	2	25
23	12.5	2	25
24	12.5	2	25
25	12.5	2	25
26	12.5	2	25
27	12.5	2	25
28	12.5	2	25
29	12.5	2	25
30	12.5	2	25
31	12.5	2	25
32	12.5	2	25
33	12.5	2	25
34	12.5	2	25
35	12.5	2	25

VB5 (19/40)

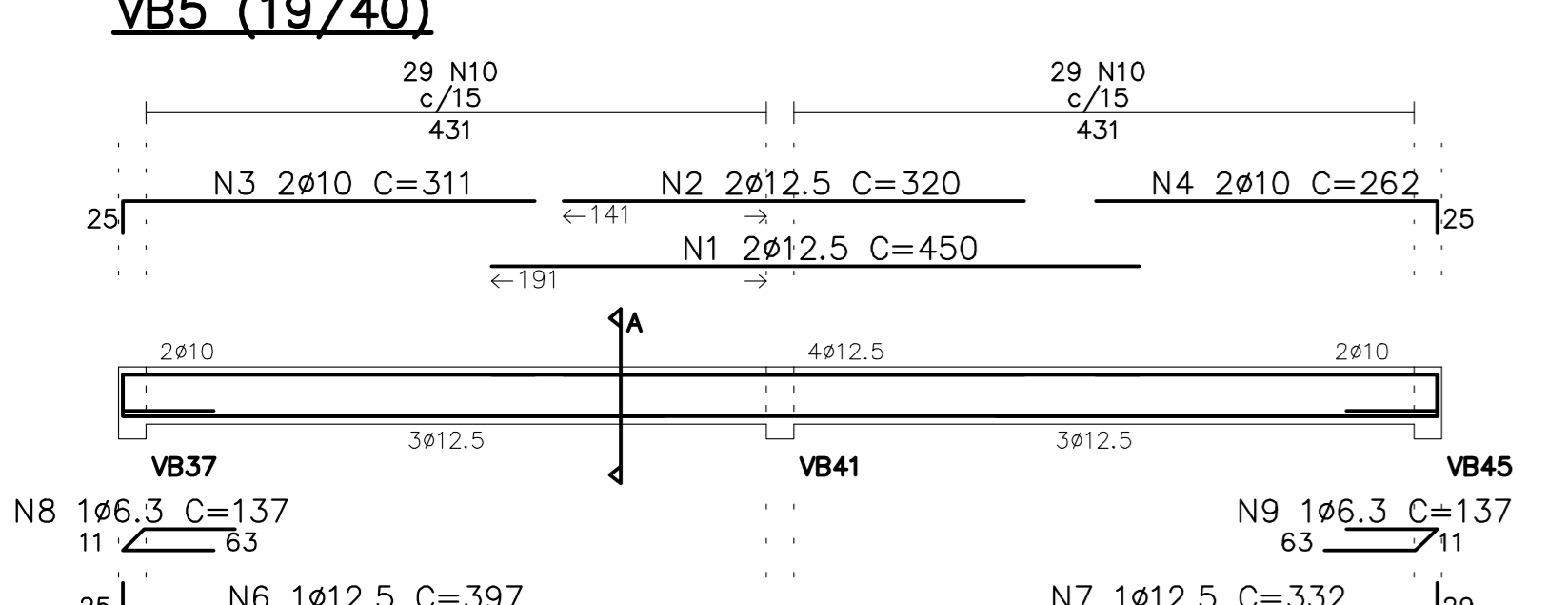

VB6 (19/40)

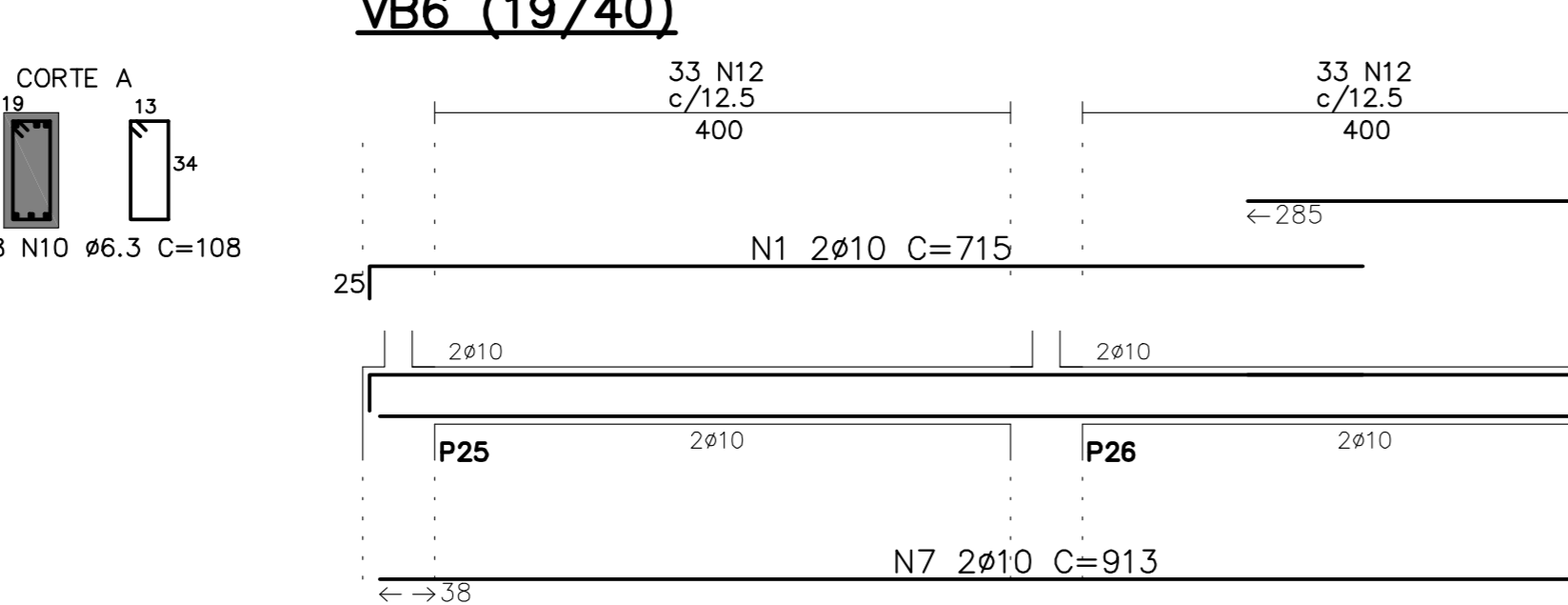

VB10 (19/40)

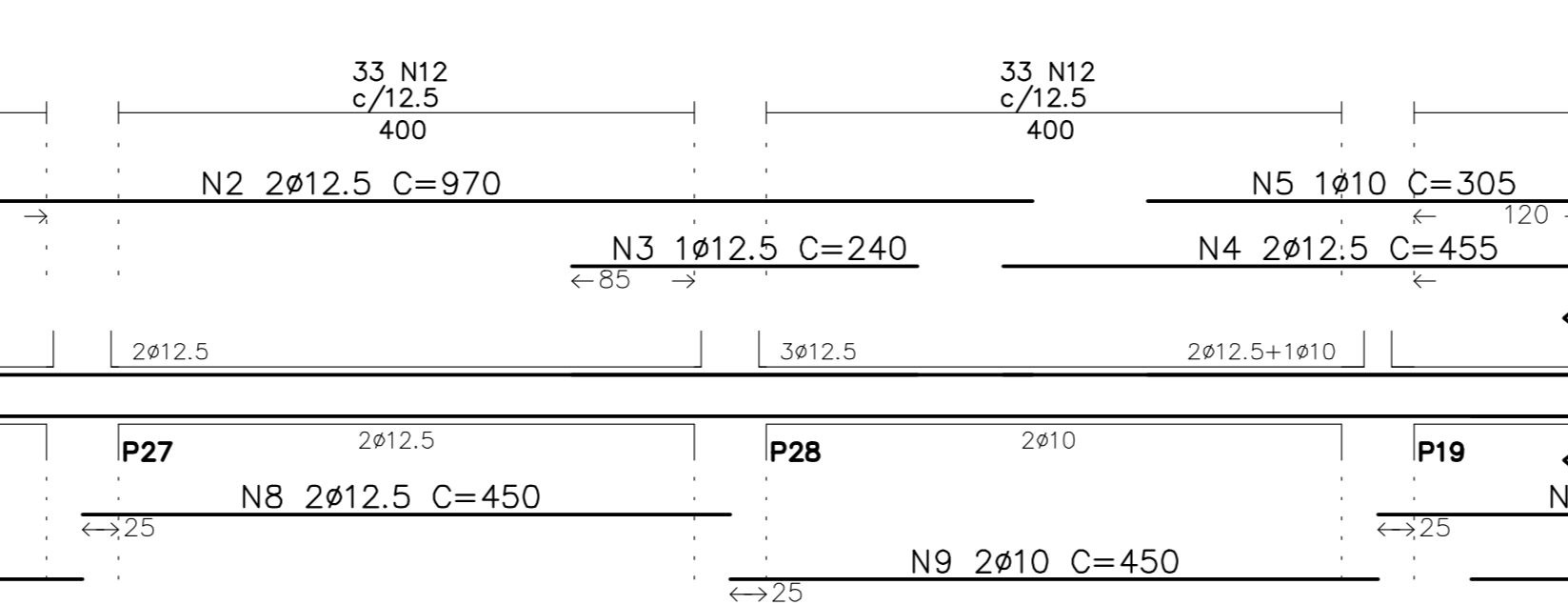

VB11 (19/40)

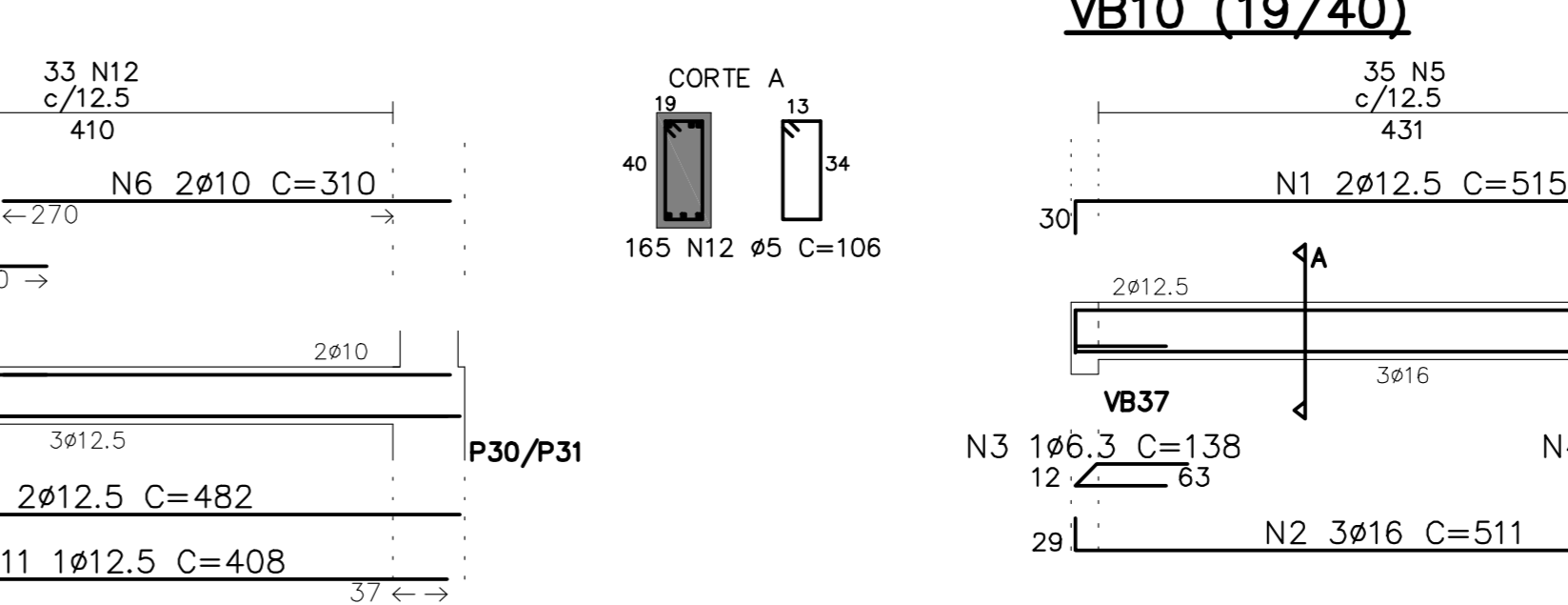

VB12 (19/40)

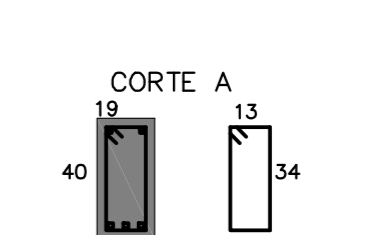
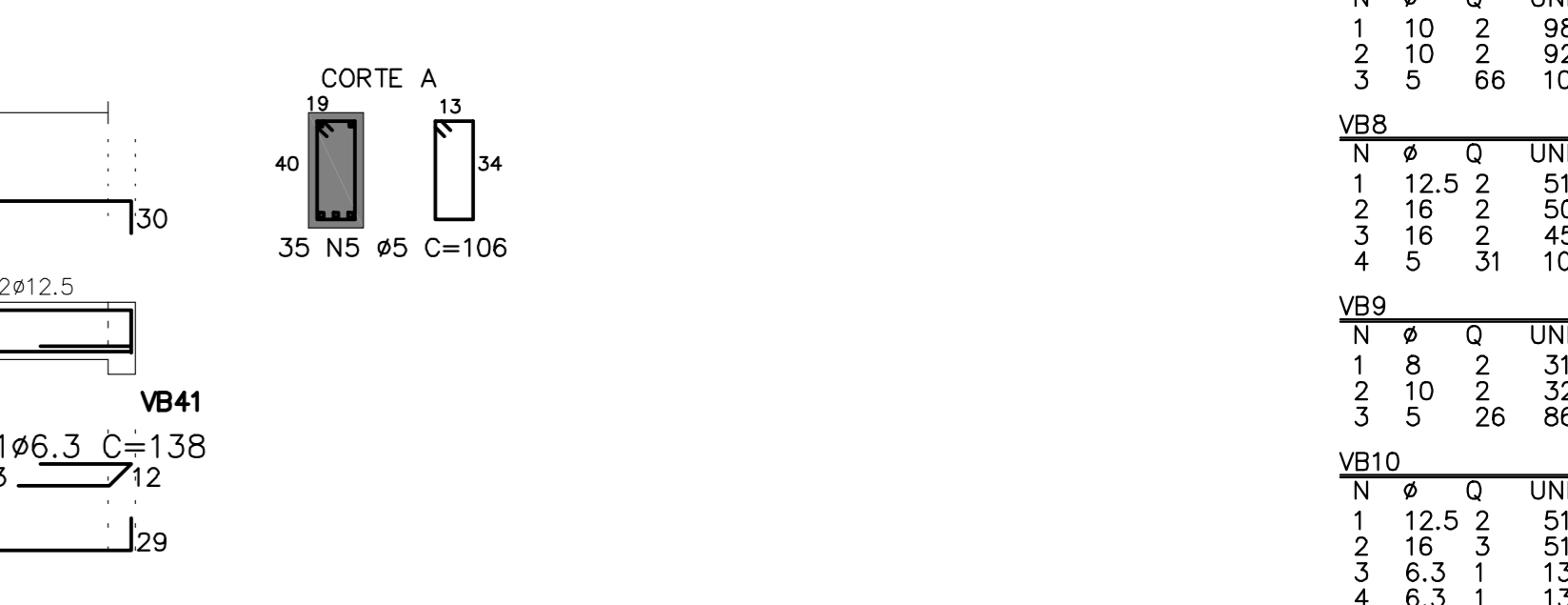

N	Q	UNI	TOTAL
1	12.5	2	25
2	12.5	2	25
3	12.5	2	25
4	12.5	2	25
5	12.5	2	25
6	12.5	2	25
7	12.5	2	25
8	12.5	2	25
9	12.5	2	25
10	12.5	2	25
11	12.5	2	25
12	12.5	2	25
13	12.5	2	25
14	12.5	2	25
15	12.5	2	25
16	12.5	2	25
17	12.5	2	25
18	12.5	2	25
19	12.5	2	25
20	12.5	2	25
21	12.5	2	25
22	12.5	2	25
23	12.5	2	25
24	12.5	2	25
25	12.5	2	25
26	12.5	2	25
27	12.5	2	25
28	12.5	2	25
29	12.5	2	25
30	12.5	2	25
31	12.5	2	25
32	12.5	2	25
33	12.5	2	25
34	12.5	2	25
35	12.5	2	25

VB13 (19/40)

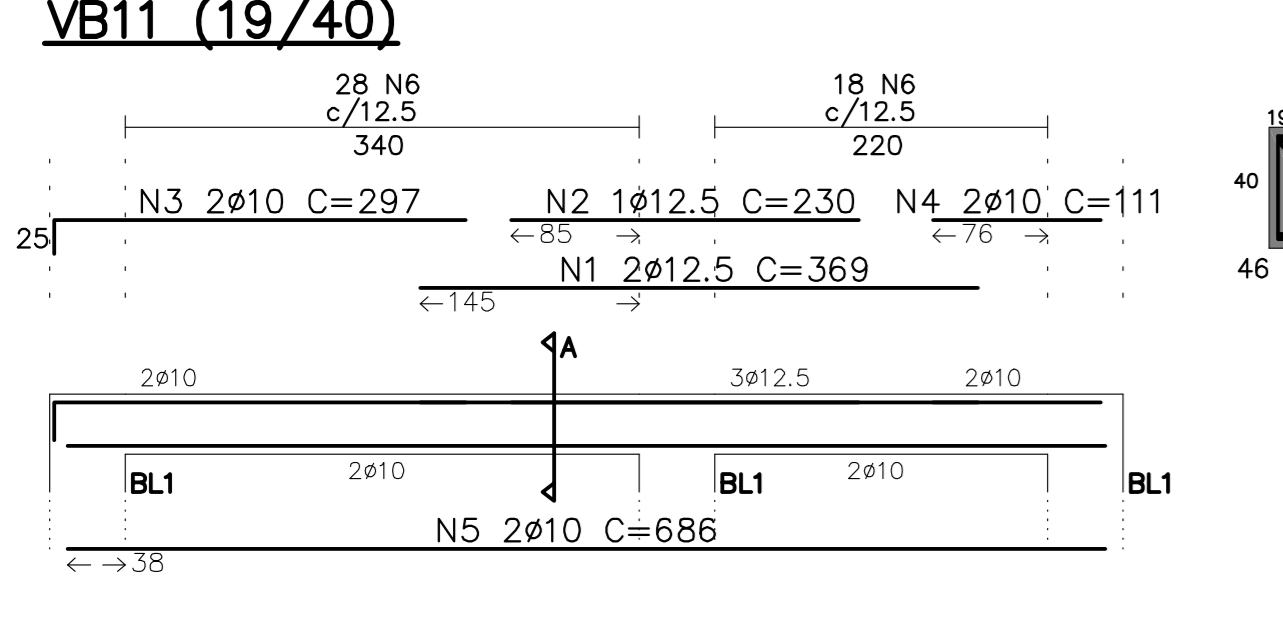

VB14 (19/40)

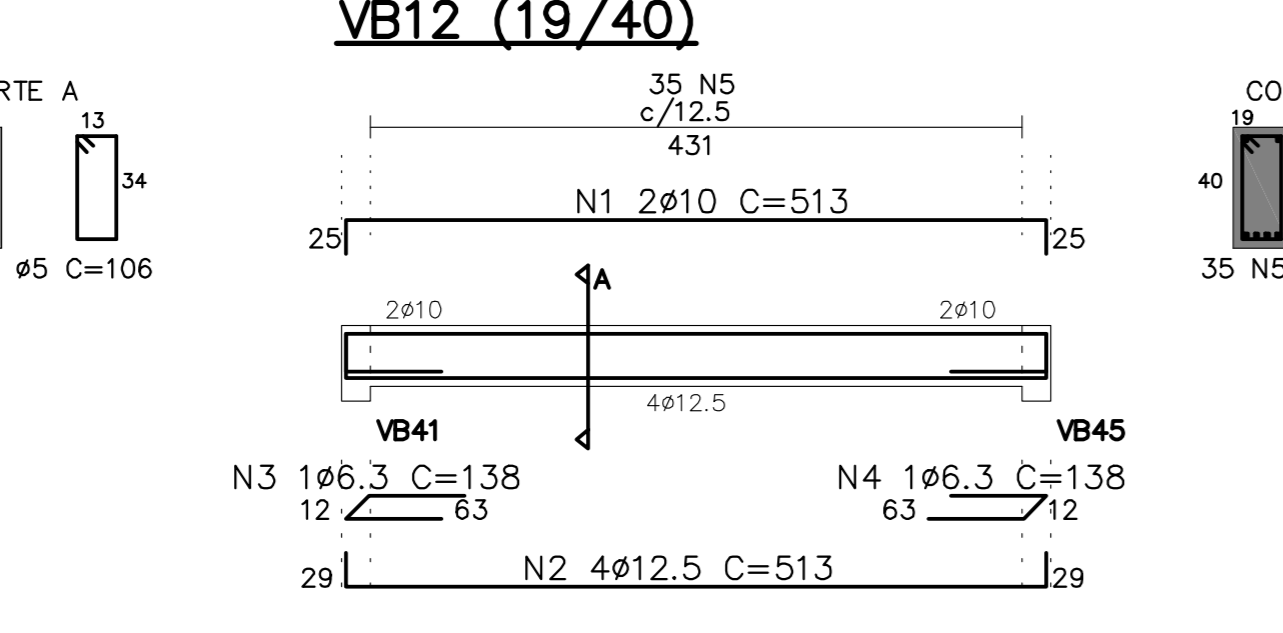

VB15 (19/50)

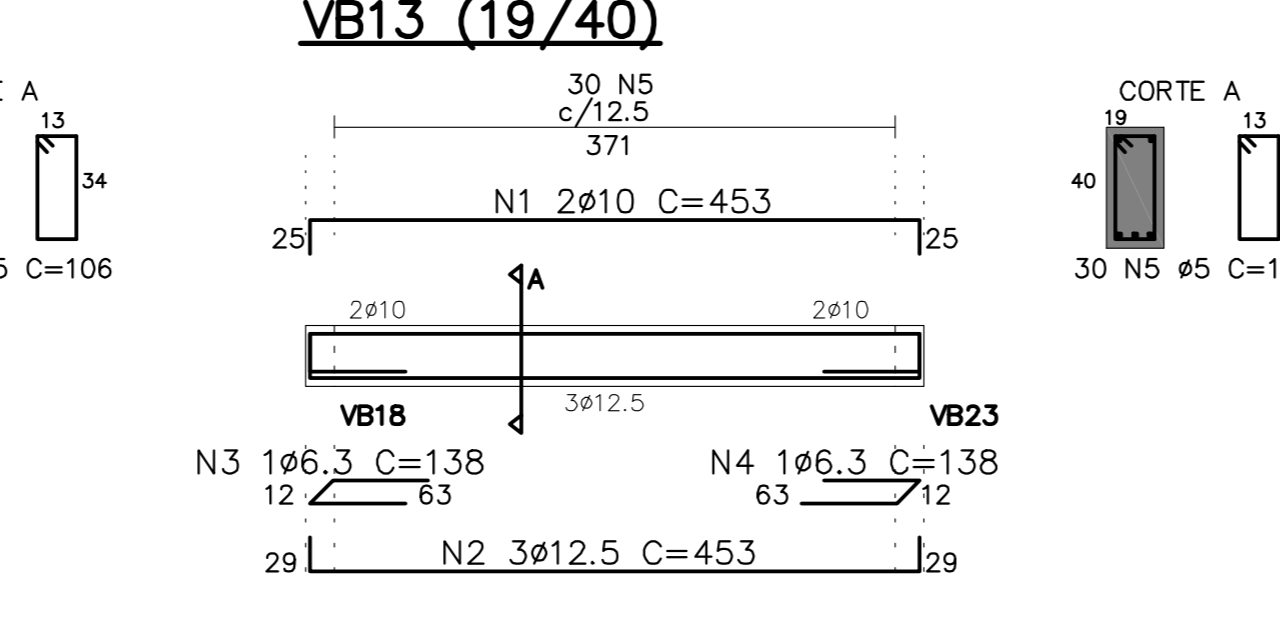

VB17 (19/50)

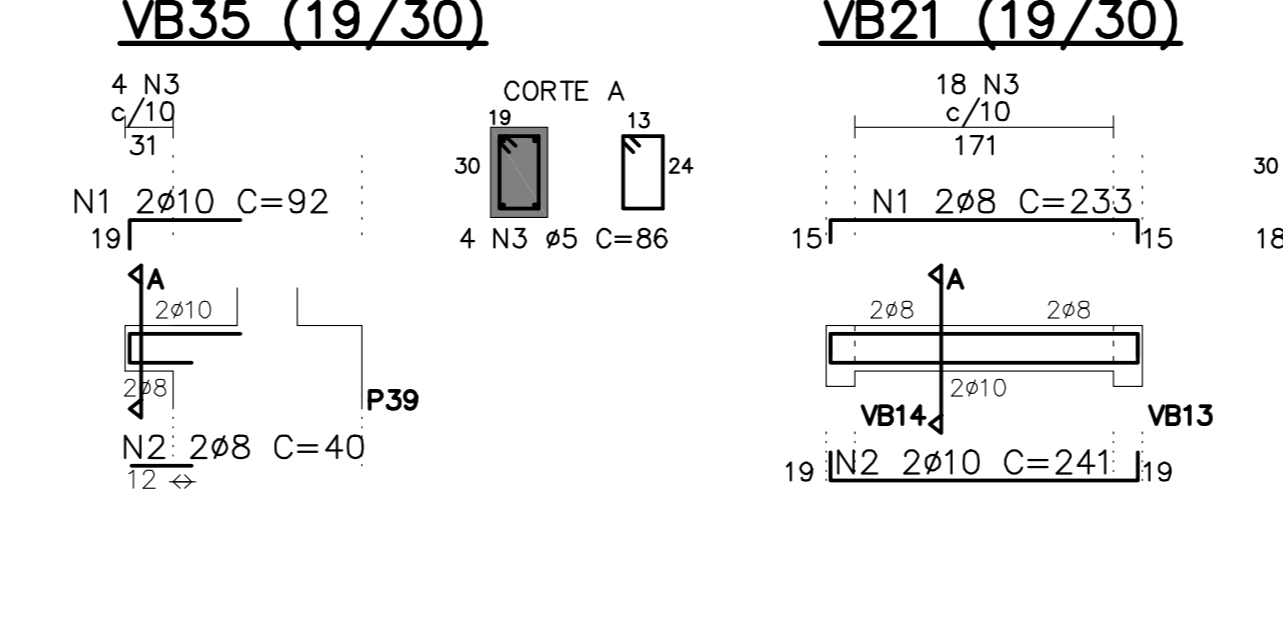

VB18 (19/30)

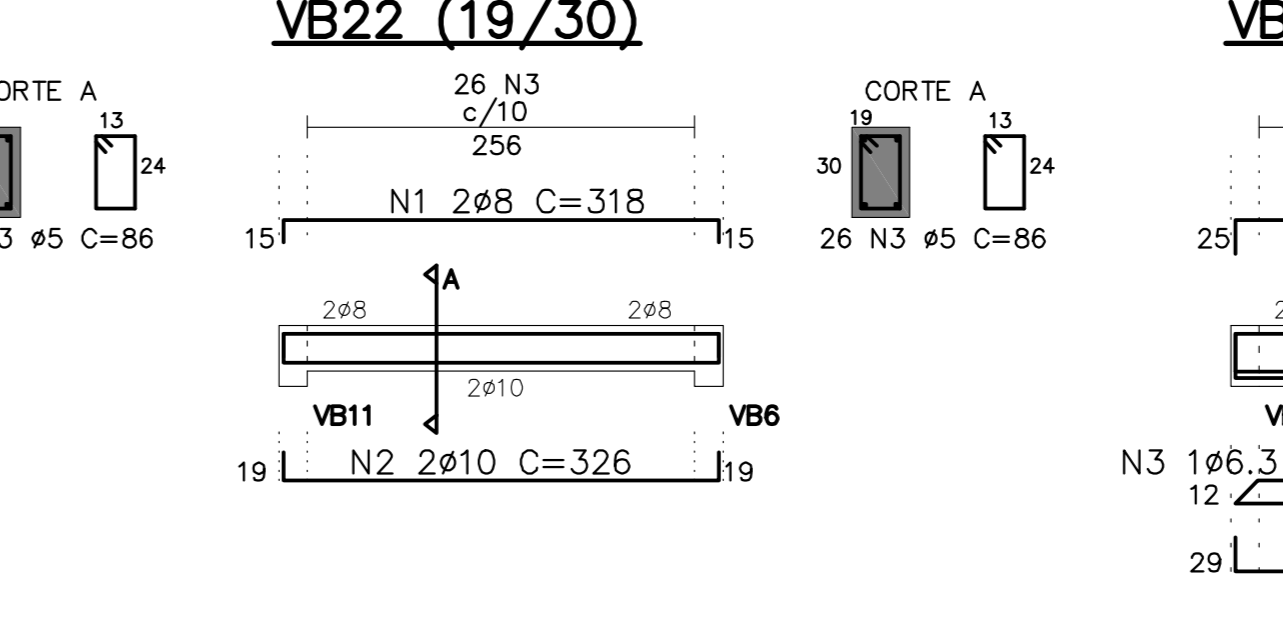

VB19=VB25=VB33=VB35 (19/30)

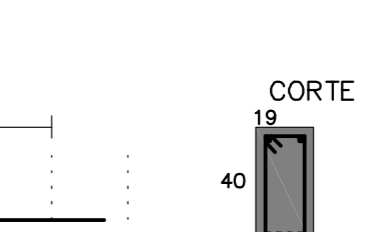
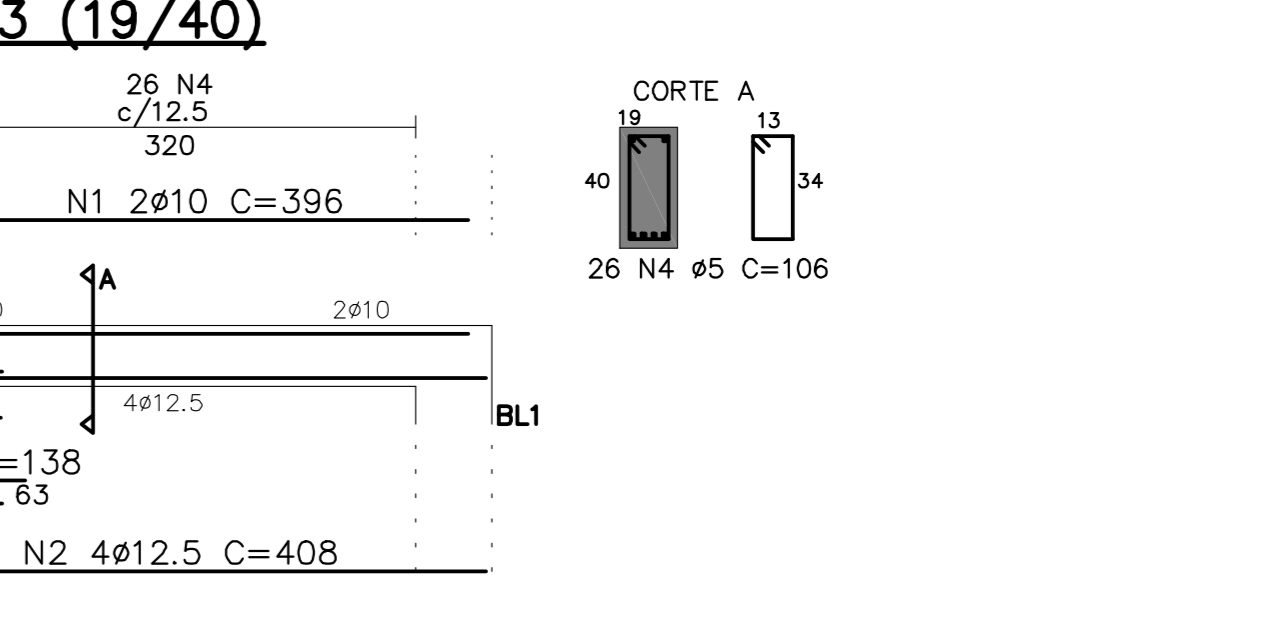

N	Q	UNI	TOTAL
1	12.5	2	25
2	12.5	2	25
3	12.5	2	25
4	12.5	2	25
5	12.5	2	25
6	12.5	2	25
7	12.5	2	25
8	12.5	2	25
9	12.5	2	25
10	12.5	2	25
11	12.5	2	25
12	12.5	2	25
13	12.5	2	25
14	12.5	2	25
15	12.5	2	25
16	12.5	2	25
17	12.5	2	25
18	12.5	2	25
19	12.5	2	25
20	12.5	2	25
21	12.5	2	25
22	12.5	2	25
23	12.5	2	25
24	12.5	2	25
25	12.5	2	25
26	12.5	2	25
27	12.5	2	25
28	12.5	2	25
29	12.5	2	25
30	12.5	2	25
31	12.5	2	25
32	12.5	2	25
33	12.5	2	25
34	12.5	2	25
35	12.5	2	25

VB16 (19/40)

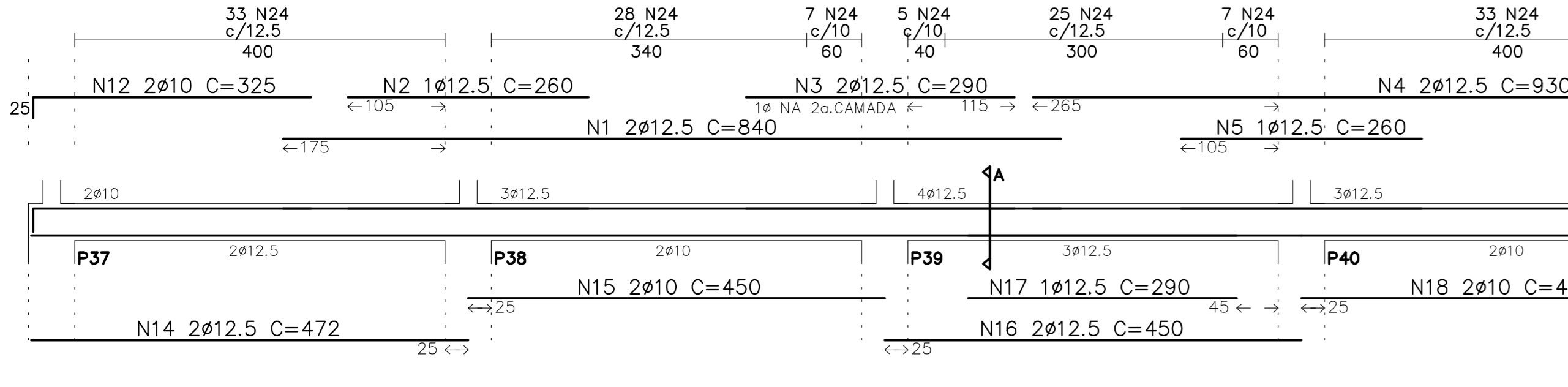

VB17 (19/40)

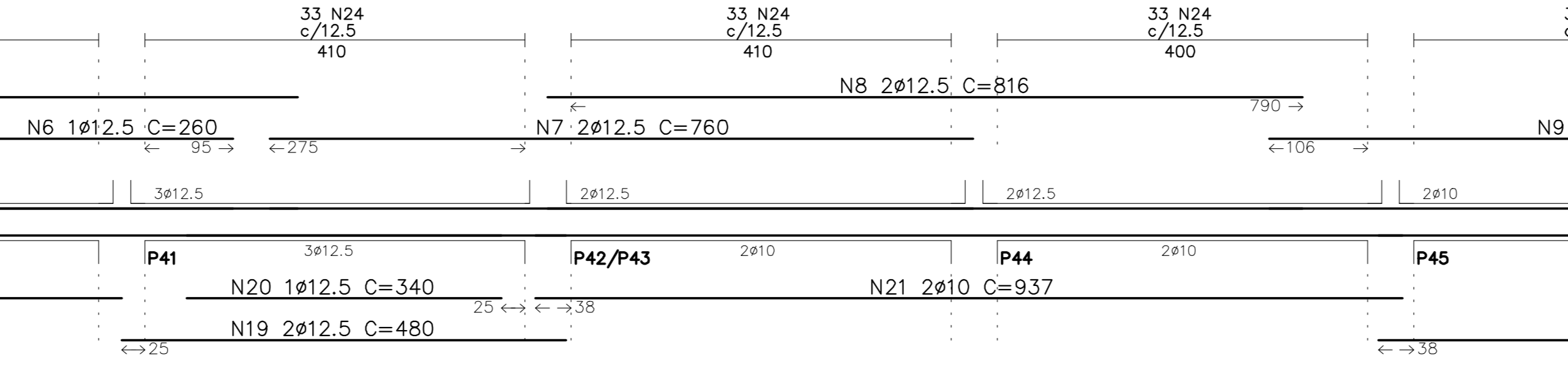

VB18 (19/30)

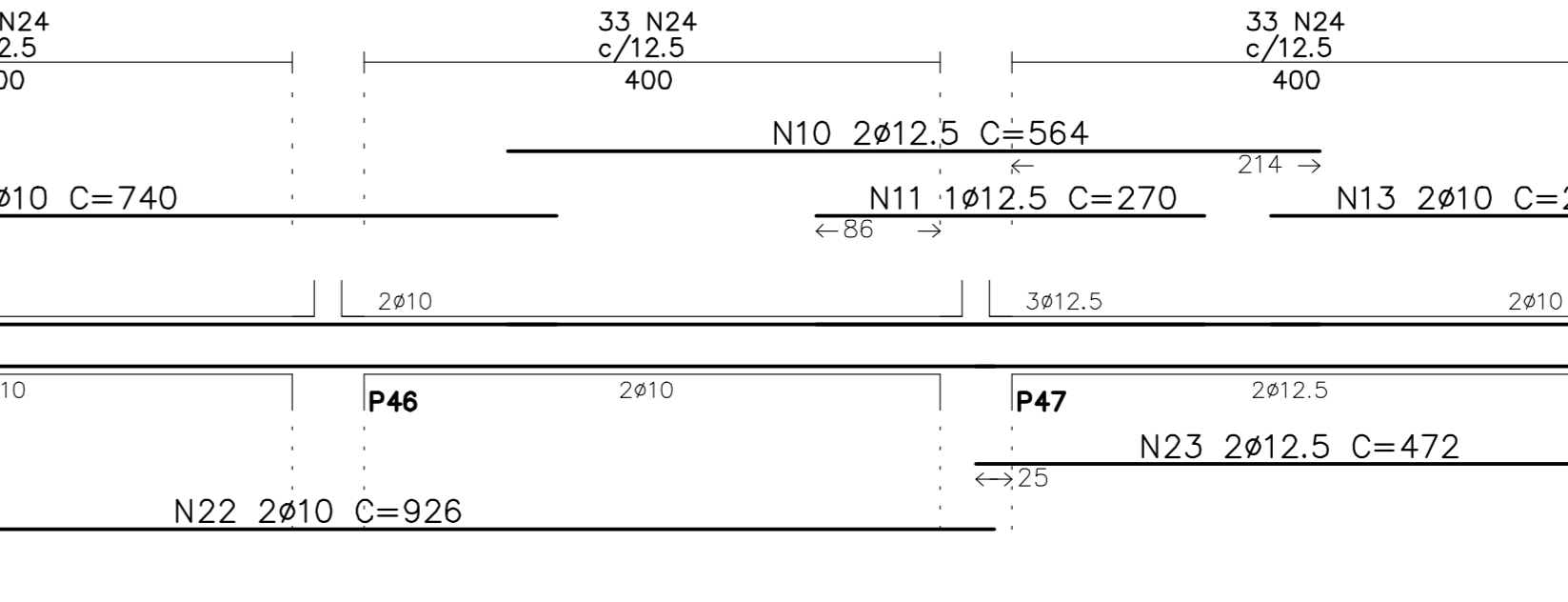

VB19 (19/30)

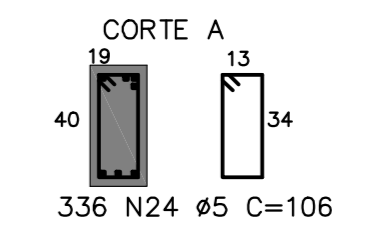

N	Q	UNI	TOTAL
1	12.5	2	25
2	12.5	2	25
3	12.5	2	25
4	12.5	2	25
5	12.5	2	25
6	12.5	2	25
7	12.5	2	25
8	12.5	2	25
9	12.5	2	25
10	12.5	2	25
11	12.5	2	25
12	12.5	2	25
13	12.5	2	25
14	12.5	2	25
15	12.5	2	25
16	12.5	2	25
17	12.5	2	25
18	12.5	2	25
19	12.5	2	25
20	12.5	2	25
21	12.5	2	25
22	12.5	2	25
23	12.5	2	25
24	12.5	2	25
25	12.5	2	25
26	12.5	2	25
27	12.5	2	25
28	12.5	2	25
29	12.5	2	25
30	12.5	2	25
31	12.5	2	25
32	12.5	2	25
33	12.5	2	25
34	12.5	2	25
35	12.5	2	25

VB20 (19/40)

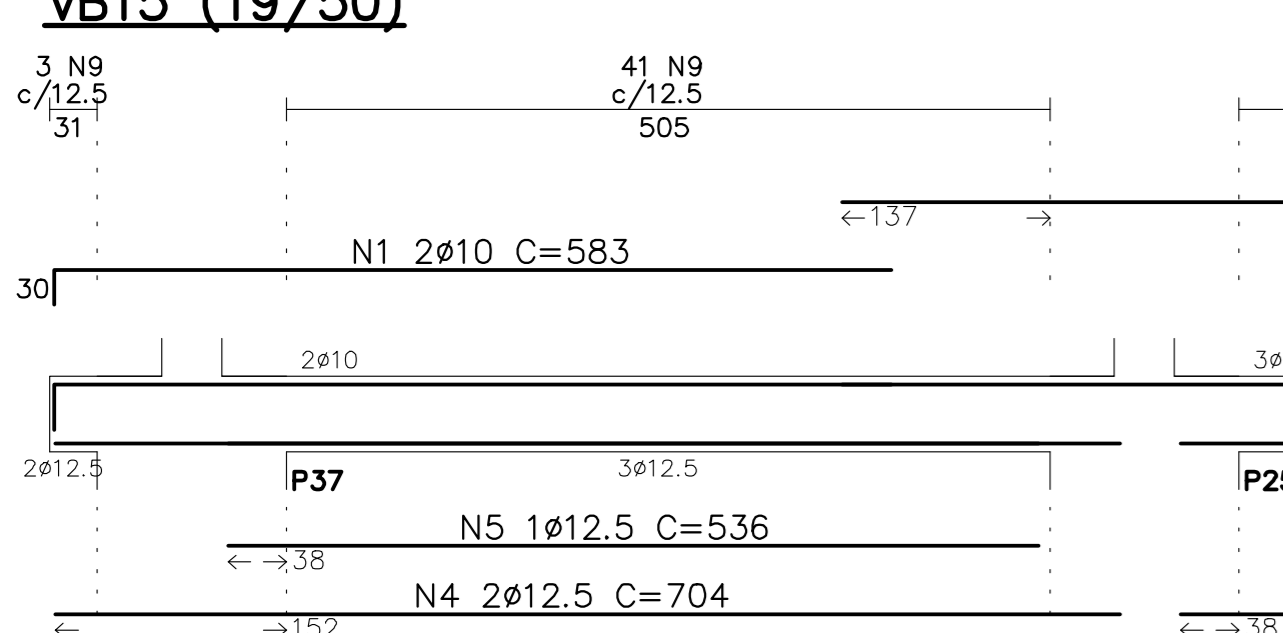

VB21 (19/40)

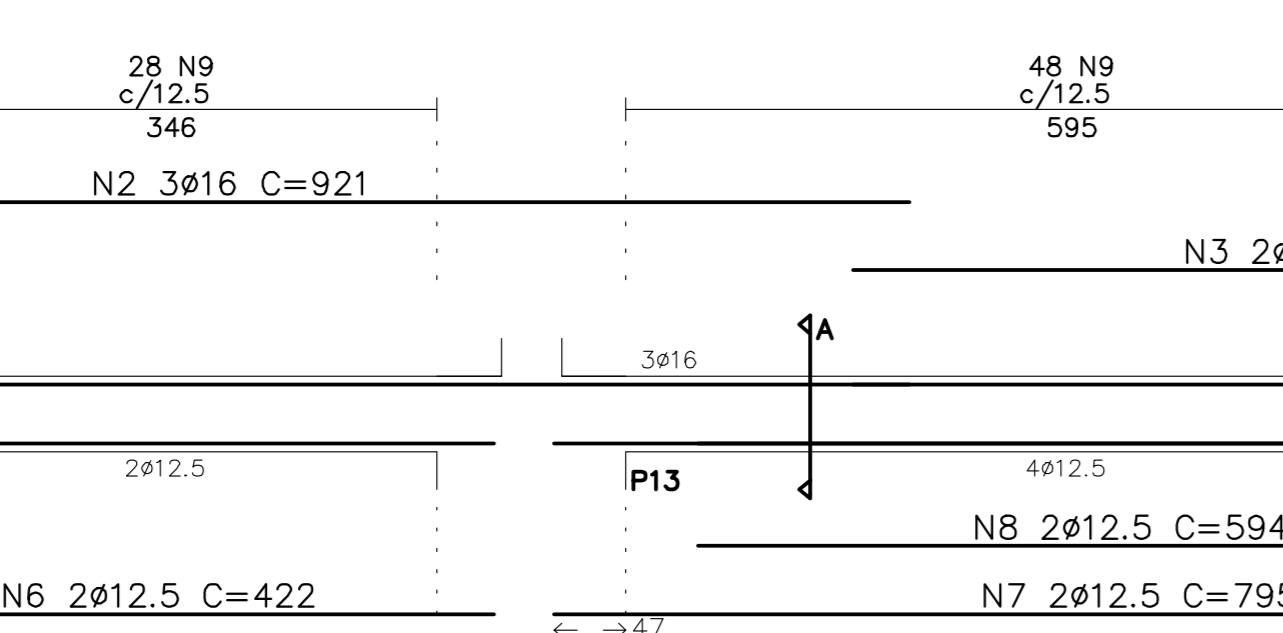

VB22 (19/30)

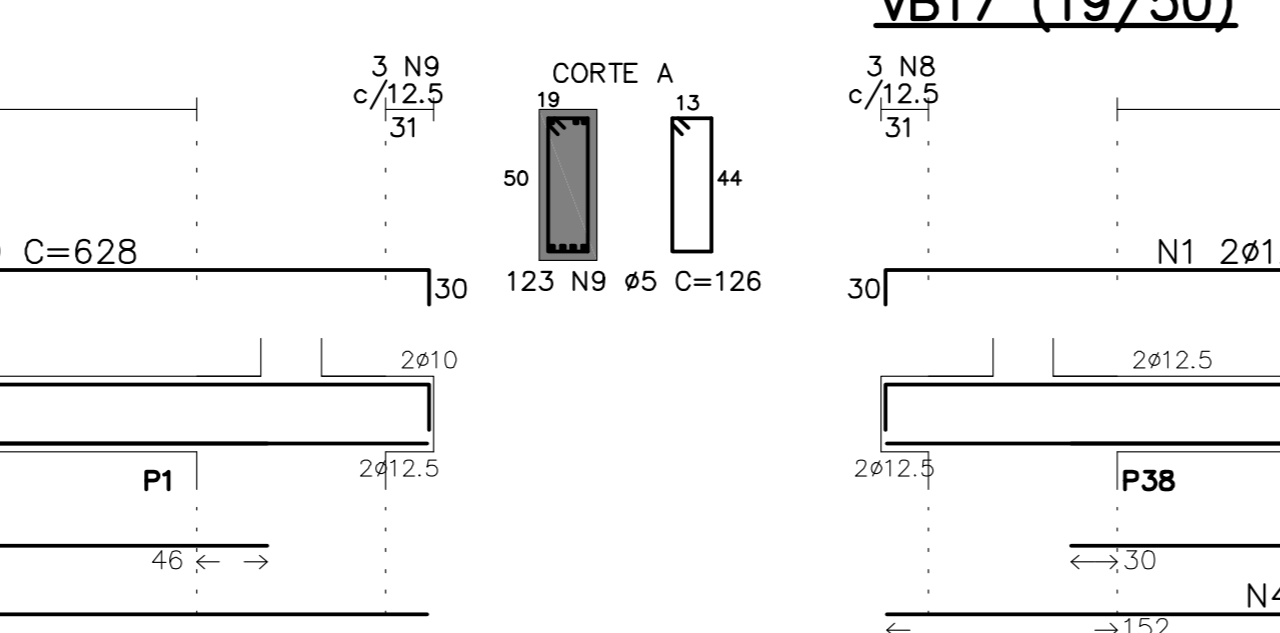

VB23 (19/40)

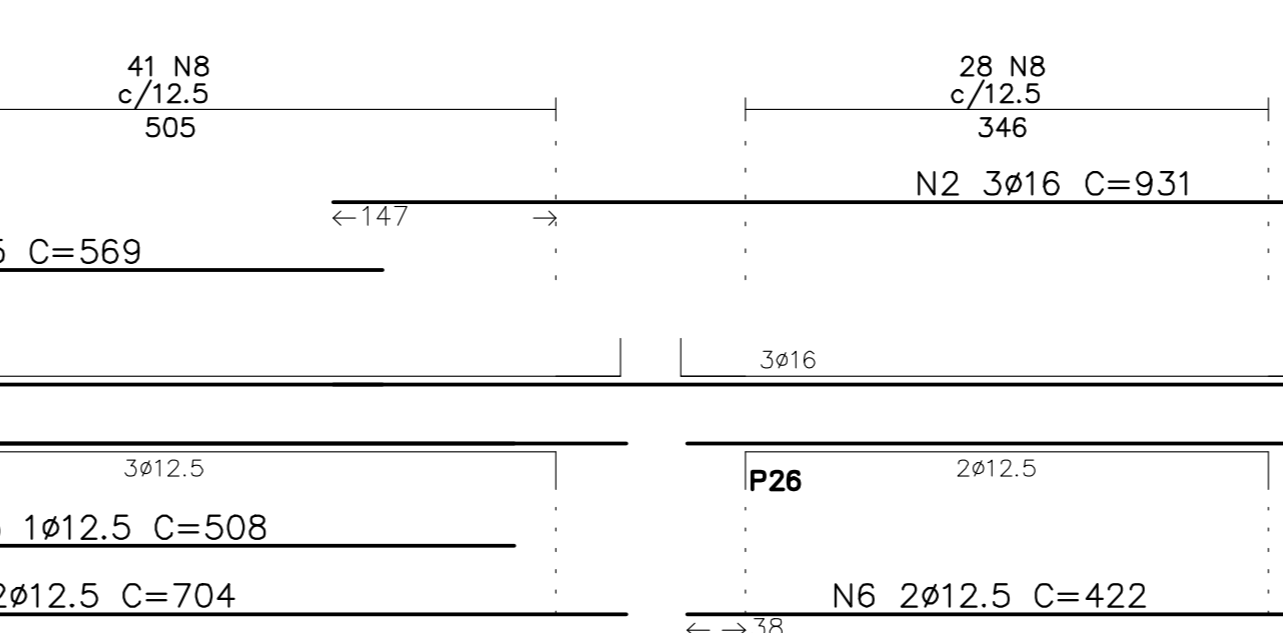

VB24 (19/30)

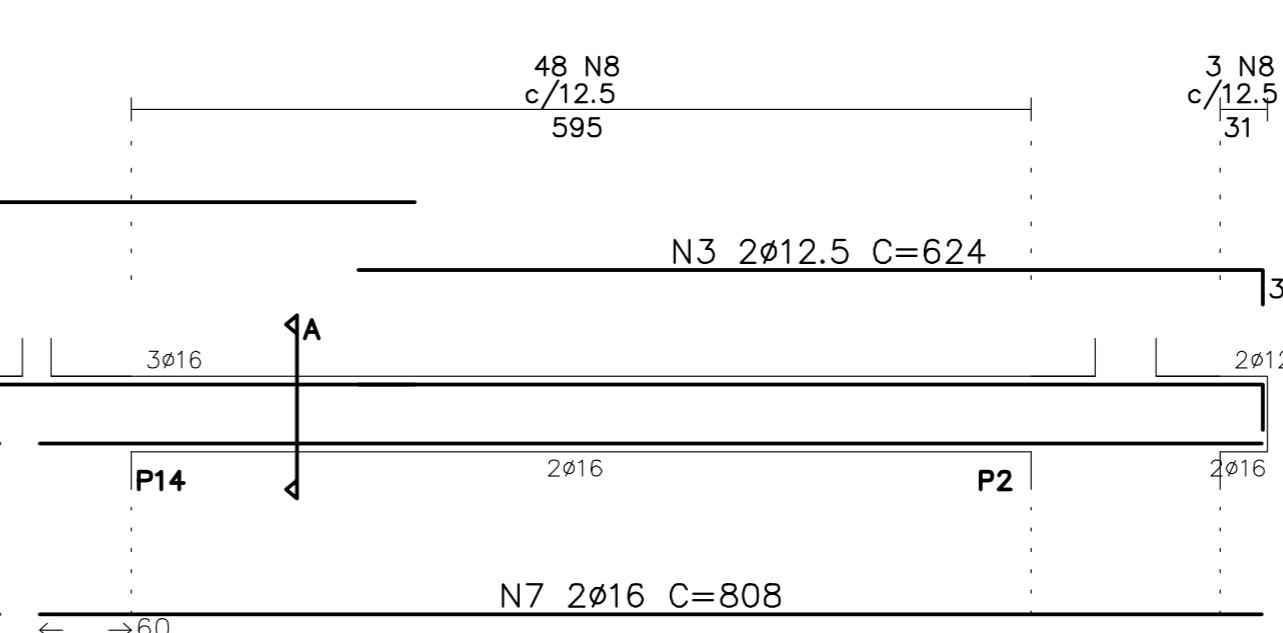

VB25 (19/30)



N	Q	UNI	TOTAL
1	12.5	2	25
2	12.5	2	25
3	12.5	2	25
4	12.5	2	25
5	12.5	2	25
6	12.5	2	25
7	12.5	2	25
8	12.5	2	25
9	12.5	2	25
10	12.5	2	25
11	12.5	2	25
12	12.5	2	25
13	12.5	2	25
14	12.5	2	25
15	12.5	2	25
16	12.5	2	25
17	12.5	2	25
18	12.5	2	25
19	12.5	2	25
20	12.5	2	25
21	12.5	2	25
22	12.5	2	25
23	12.5	2	25
24	12.5	2	25
25	12.5	2	25
26	12.5	2	25
27	12.5	2	25
28	12.5	2	25
29	12.5	2	25
30	12.5	2	25
31	12.5	2	25
32	12.5	2	25
33	12.5	2	25
34	12.5	2	25
35	12.5	2	25

**PREFEITURA DO MUNICÍPIO DE JAHU**  
 Fundação em 15 de agosto de 1937  
 Rua Francisco de Sá, Centro - Jahu - SP  
 Telefone: (14) 3002-1716  
 www.jahu.sp.gov.br

**SHPU**

OBRA: Construção Inicial de Creche no Residencial Altos da Cidade  
 PROJETO: Fundações - Armação das Vigas de Fundações (1/2)  
 ENDEREÇO: Lote formado pela Avenida Lauro Fracchetti, Rua Cibely Comien Tonato e Rua Waldomiro Sorani, Residencial Cidade Alta, 22-1640 C/S 48-3037 O/W, Jahu/SP

ESCALA: Indicada DATA: JUN/2023 FOLHA: 05/08

Tiago Capobianco Morando  
 CREA-SP 070000000-0

"JAHU CAPITAL DO CAÇADO FEMININO" "BARRIO DE BARRIS - HERO NACIONAL"